

# Instruction Manual

Product Number: JOY

Thank you for purchasing the THERMOS Vacuum Insulated Portable Mug.  
This page gives detailed handling instructions for the product.

**For Household Use**

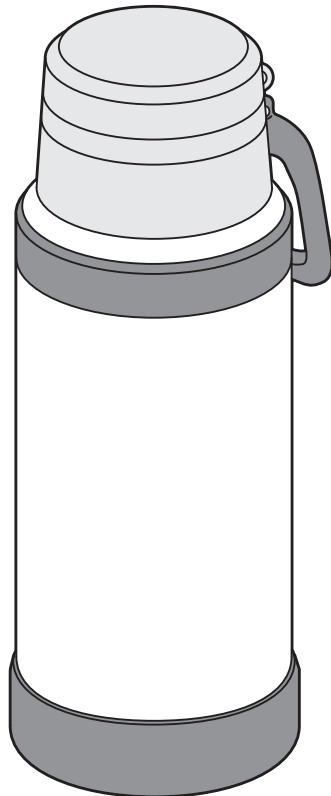

## Before Use

- Check that all the parts are included.
- Thoroughly clean all parts.

If you overfill the liquid, the contents may leak.

Fill drink to here!

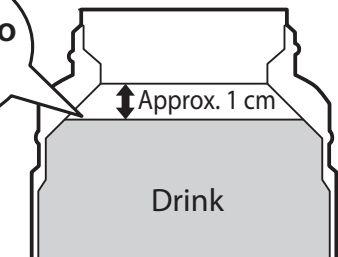

(Main body cross section)

## Contents

### Before Use

- P.1 Part Names
- P.2 Precautions
- P.5 Notes on Use

### Usage Instructions

- P.6 How to Use
- P.8 Product Care

### Troubleshooting

- P.11 In This Case
- P.12 How to Purchase Replacement Parts (Sold Separately)

# Part Names

Before use, check that all the parts are included.

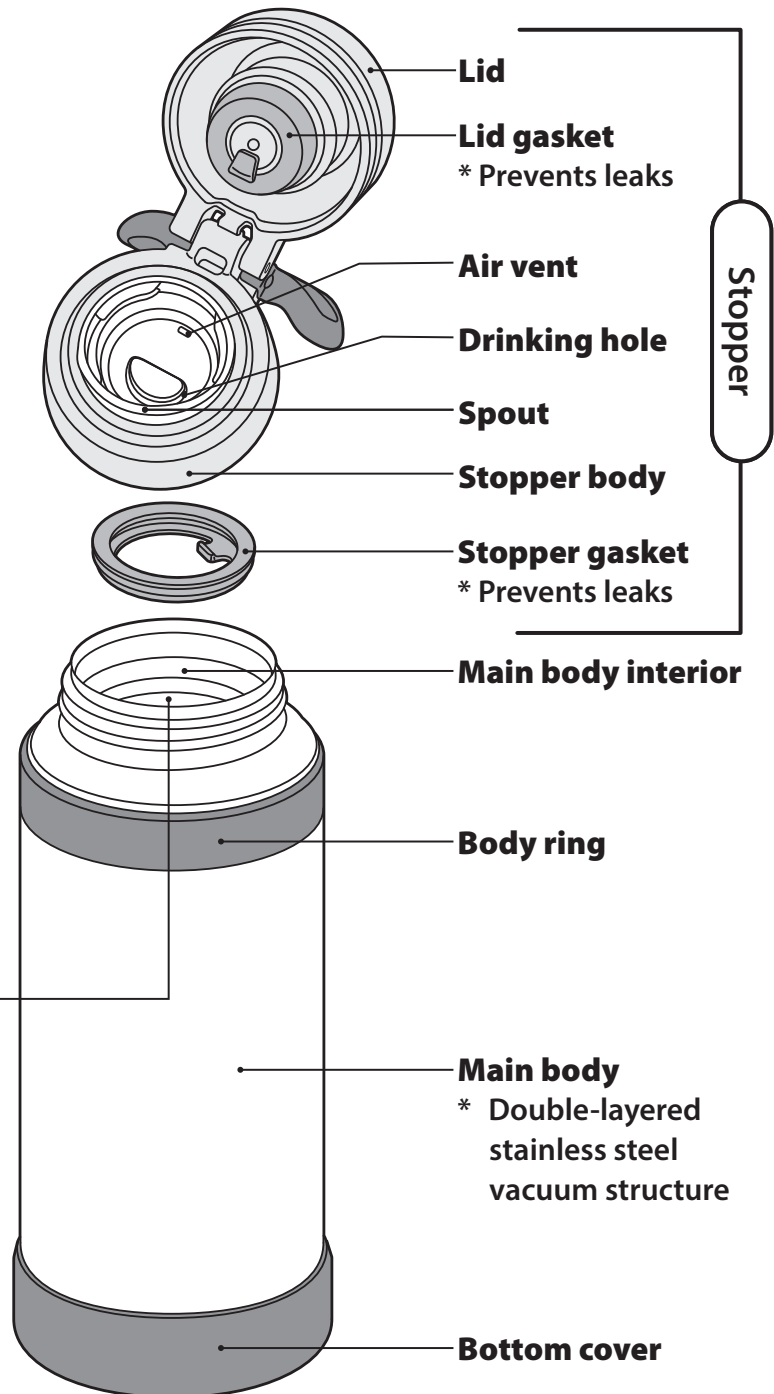
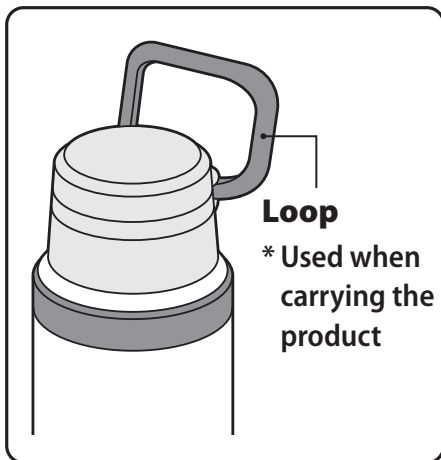

## ⚠ Caution

Keep the drink level below the position illustrated. If overfilled, the contents may leak.

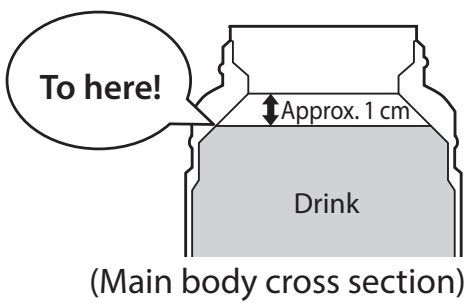

Properly attach the stopper's two dedicated gaskets before use.

\* Otherwise, the contents may leak.

# Precautions

Read these precautions carefully before use and be sure to follow them.

## Meaning of displayed markings

■ To ensure that this product is properly used, the extent of harm or damage caused by improper usage is categorized as follows.

 <b>Warning</b>	This mark indicates content that could result in death or serious injury.	 <b>Caution</b>	This mark indicates content that could result in minor injury or property damage.
--	---	--	---

■ Symbols

 <b>Prohibited</b>	This mark indicates actions to avoid.	 <b>Required</b>	This mark indicates actions that must be followed.
---	---------------------------------------	---	--

## Warning

 **Keep this product out of reach of young children.**  
Prohibited **Also, make sure it is not used as a toy.**

- \* Small parts are a choking hazard and are at risk of being swallowed.
- Also, this behavior may result in burns or injury.



## Caution

 **Do not use this product for purposes other than drink storage.**  
Prohibited



- \* Doing so may cause injury.

 **Do not leave this product near a stove, gas heater, or other fire source.**  
Prohibited

- \* Doing so may cause burns. Additionally, the product may become deformed, possibly causing leaks that could result in burns or staining your belongings.

 **When drinking a hot beverage, drink slowly and do not tilt the main body quickly.**  
Required

- \* Otherwise, the rush of hot liquid may result in burns and other issues.



 **Properly attach the stopper's two dedicated gaskets.**  
Required  P.9 ① ②

- \* Otherwise, the contents may leak, possibly resulting in burns or staining your belongings.

 **Keep the drink level below the prescribed position illustrated.**  
Required

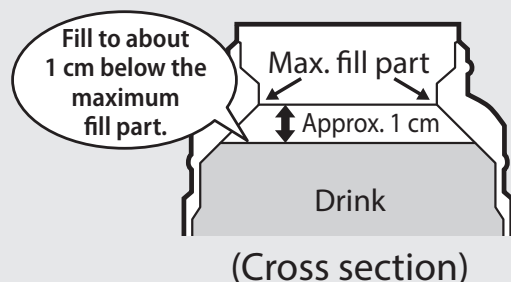
- \* Overfilling may cause the drink to overflow when closing the stopper. Also, the contents may leak during use, possibly resulting in burns or staining your belongings.



 **Close the stopper securely.**  
Required  P.6 ③

- \* Otherwise, the contents may leak, possibly resulting in burns or staining your belongings.

 **Do not leave your beverage for too long inside.**  
Required

- \* Otherwise, the drink may spoil or go bad.

# Precautions

Never put the following inside the container.

-  **Dry ice and carbonated drinks**  
Prohibited \* If the internal pressure rises, the stopper may not open or may fly off, causing the contents to burst out and possibly resulting in injury or staining your belongings.

-  **Tea leaves and pulp**  
Prohibited \* If the crevices become clogged, the contents may leak, possibly resulting in burns or staining your belongings.

To care for the product, be sure to follow the instructions below.

-  **After use, immediately clean the product and thoroughly dry it.**  
Required \* Residue left after washing may grow bacteria and contaminate your drinks.

-  **Do not boil this product.**  
Prohibited \* Heat may cause the product to become deformed, possibly causing leaks that could result in burns or staining your belongings.

-  **Remove the body ring and bottom cover from the main body, clean each part, and thoroughly dry the parts before reattaching them.**  
Required \* Otherwise, cleaning water may seep out and stain your belongings or cause rust. If you attach the body ring and bottom cover while they are wet, the main body may slip out and fall, possibly resulting in injury or damaging your belongings.

-  **Do not tilt or shake the main body when closing the stopper.**  
Prohibited \* Otherwise, the drink may overflow. Also, the contents may leak, possibly resulting in burns or staining your belongings.

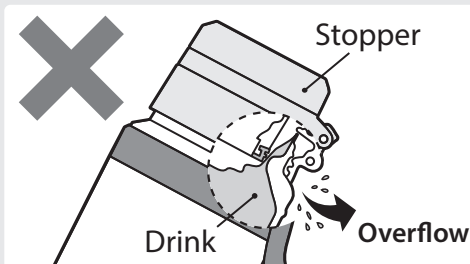

-  **Avoid dropping the product, knocking it, or otherwise subjecting it to strong impact.**  
Prohibited

- \* Doing so may cause injury, or the contents may leak, possibly resulting in burns or staining your belongings. It may also result in insufficient heat and cold retention or a damaged stopper.

-  **Do not leave a drink in this product for a long time.**  
Prohibited

- \* Otherwise, the drink may spoil or go bad. Also, if the internal pressure rises due to gases released through spoilage, the stopper may not open or may fly off, causing the contents to burst out and possibly resulting in injury or staining your belongings.

-  **Avoid cramming large pieces of ice inside. Break them into smaller pieces.**  
Required

- \* The maximum fill part on the inside of the main body may become deformed possibly causing leaks that could result in burns or staining your belongings.

-  **Do not attach or remove the stopper while the lid of the stopper is open.**  
Prohibited

- \* Deformation or damage may cause leaks, possibly resulting in burns or staining your belongings.

-  **Avoid using this product if you hear sloshing sounds coming from inside of the double-layered vacuum structure (vacuum layer).**  
Prohibited

- \* If liquid from the vacuum layer seeps into the main body, consuming it may cause health issues.

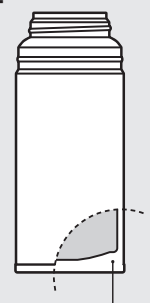

Vacuum layer

-  **Do not swing around the product while holding the loop and do not pull the loop forcefully.**  
Prohibited

- \* Doing so may cause the product to strike people around you, possibly causing injury. Pulling the loop forcefully may damage the product.

# Precautions



Prohibited

**Do not put this product in the microwave.**

- \* The metal parts will spark, possibly resulting in damage to the microwave.
- \* Heat may cause the product to become deformed, possibly causing leaks that could result in burns or staining your belongings.



Prohibited

**Never modify, disassemble, or repair the product.**

- \* Doing so may cause damage or result in an accident.



Required

**Attach only the dedicated parts to this product.**

- \* Otherwise, the contents may leak, possibly resulting in burns or staining your belongings.



Required

**Be careful of tipping over the product when the main body contains a drink.**

- \* Otherwise, the drink may spill, possibly resulting in burns or staining your belongings.



Prohibited

**If the heat or cold retention is reduced, stop using the product.**

- \* Storing a hot drink will heat up the main body, possibly resulting in burns.



Prohibited

**Do not hold the product upside down while holding the bottom cover.**

- \* Doing so may cause the main body to fall out, possibly resulting in injury or damaging the product.

# Notes on Use

**Refrain from inserting soups and other high-salt content items, as well as warm sports drinks, into the container.**

\* The main body uses stainless steel for its interior lining. However, exposure to salt may potentially cause rusting and diminish its ability to keep beverages hot or cold for an extended period.

**After use, immediately clean the product and thoroughly dry it. If you have gone out or otherwise cannot properly care for the product after use, quickly and thoroughly rinse the interior of the main body with water.**

\* Otherwise, the product may rust or lose its heat and cold retention.

**When placing the product in a bag, place it upright to prevent any potential leaks.**

**Before going out, turn the product upside down to check for leaks.**

\* If the product leaks, check the items listed in "In This Case" on P.11.

**Do not put this product in the freezer.**

\* Doing so may result in damage or insufficient heat and cold retention.

**When carrying the product, be sure to follow the instructions below.**

● **Confirm that the stopper and lid are securely closed.**

● **Do not turn the stopper in the direction that loosens it or subject it to strong impact.**

\* Doing so may loosen the stopper and cause the main body to drop.

**Do not open or close the stopper while holding the loop.**

\* Doing so may damage the loop.

# How to Use

Thoroughly clean all parts before use.

## 1 Remove the stopper

Twist the stopper in the direction of the arrow to remove it.

### Before use

- Thoroughly clean the stopper and the inside of the main body. (☞ P.8)
- Confirm that the lid gasket and stopper gasket are properly attached. (☞ P.9④, P.10⑤)

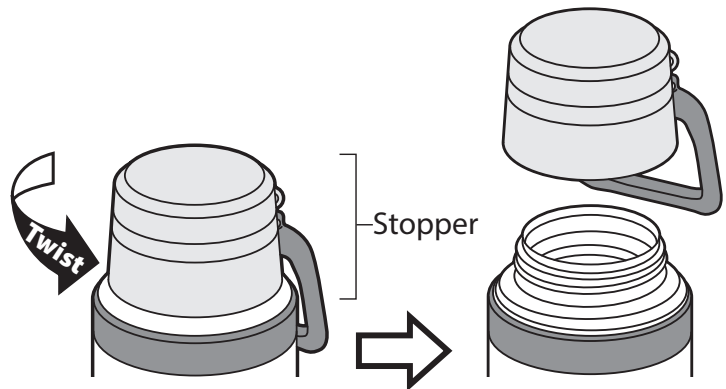

## 2 Pour in your drink

Keep the drink level below the prescribed position illustrated. Overfilling may cause the drink to overflow when closing the stopper.



Before inserting the content, insert a small amount of hot water (or cold water) into the main body to preheat (or precool) the inside for about 1 minute. Doing so will increase its heat (or cold) retention ability.

### Caution

Fill to about 1 cm below the maximum fill part.

Max. fill part  
Approx. 1 cm

Drink

(Cross section)

## 3 Close the stopper

Twist the stopper in the direction of the arrow and close it securely.

\* Confirm that the lid is securely closed.

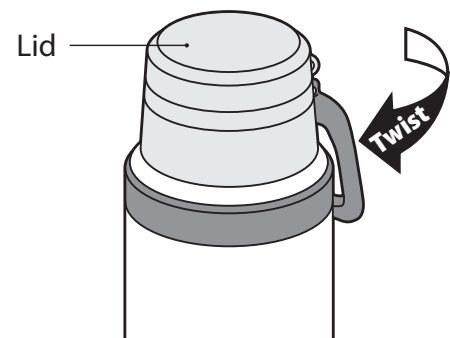

### Caution

Do not tilt or shake the main body when closing the stopper.

\* If the drink overflows, it may spill, possibly resulting in burns or staining your belongings.

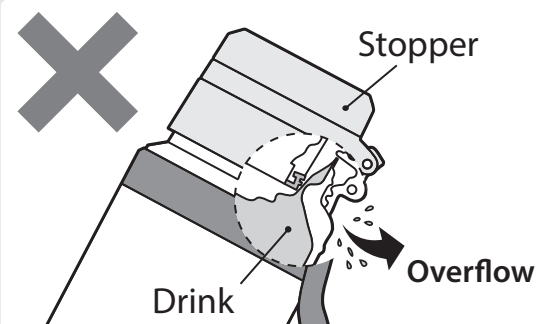

# How to Use

## 4 Drink your beverage

- ① With the main body upright, twist the lid in the direction of the arrow to open it.

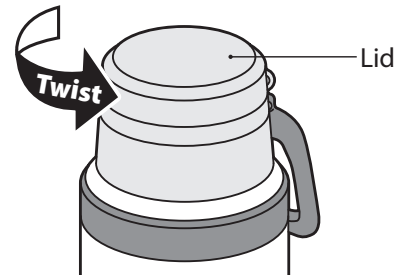

- ② Fix the lid to the hinge section.

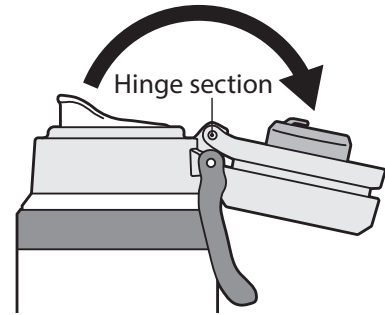

- ③ Bring the spout to your mouth, and drink while tilting slowly.

### **Caution**

When the product contains a hot drink, be careful of burns.

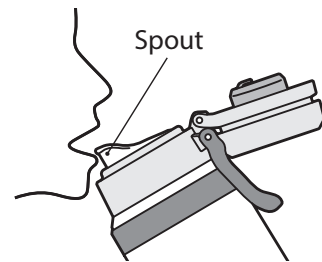

## 5 When finished drinking

With the main body upright, twist the lid in the direction of the arrow to close it securely.

### **Caution**

Do not leave the lid open.

\* If the product tips over, the drink may spill, possibly resulting in burns or staining your belongings.

When placing the product in a bag, place it upright to prevent any potential leaks.

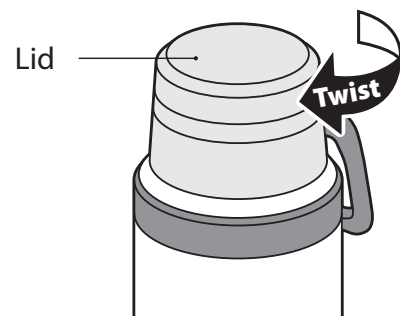

### **When carrying the product**

- Confirm that the stopper and lid are securely closed.
- Do not turn the stopper in the direction that loosens it or subject it to strong impact.



# Product Care

To prevent smells, stains, and mold and keep the product clean for a long time, always properly maintain it after use.

- After use, immediately clean the product and thoroughly dry it.
- Remove each part and clean them thoroughly.
- If you will not be using the product for a long time, clean it thoroughly to remove any dirt, thoroughly dry it, and then store it in a place that is not too hot or humid.

Part name How to wash	Stopper		Main body		Body ring Bottom cover
	Loop Lid Stopper body	Lid gasket Stopper gasket	Inside	Outside	
Running water rinse	✓	✓	✓	✓	✓
Soak and wash	✓	✓	✓	✗	✓
Bleach	Oxygen-based	✓	✓	✗	✓
	Chlorine-based	✗	✓	✗	✓
Dishwasher* Dish dryer	✓	✓	✓	✓	✓
Heat resistance	100°C	140°C	—	—	140°C

\* Before using a dishwasher, dryer, and detergent, check the instruction manuals to confirm the conditions of washable parts (heat resistance, etc.) and the washing method.

## Precautions during Product Care

Before performing product care, read these precautions carefully and be sure to follow them.



### Do not boil this product.

**Prohibited** \* Heat may cause the product to become deformed, possibly causing leaks that could result in burns or staining your belongings.



### If using a dishwasher, do not place the main body on the dish rack where the metal is exposed.

**Prohibited** \* Otherwise, the paint or printing may peel off.



### Do not use chlorine bleach (except on the gaskets, body ring, and bottom cover)

**Prohibited** \* Otherwise, the product may rust or lose its heat and cold retention. Doing so may also damage the stopper.



### Do not use paint thinner, benzene, steel scrubbers, polishing powder, or cleansers to clean this product.

**Prohibited** \* Doing so may cause rust, scratches, or damage.



### Remove the body ring and the bottom cover from the main body, clean each part, and thoroughly dry the parts before reattaching them.

**Required** \* Otherwise, cleaning water may seep out and stain your belongings or cause rust. Also, attaching the body ring and bottom cover while they are wet may cause the main body to fall out, possibly resulting in injury or damaging the product.



### Do not wash the outside of the main body by soaking.

**Prohibited** \* Doing so may cause discoloration or peeling of the paint and printing.

# Product Care

## How to attach the gaskets

■ How to remove the stopper (☞ P.6 ①)

### ① How to attach the lid gasket

Check which side is the top or bottom, and attach the gasket properly to the lid. After you attach it, press evenly around the gasket with your fingers to ensure that no part is raised.

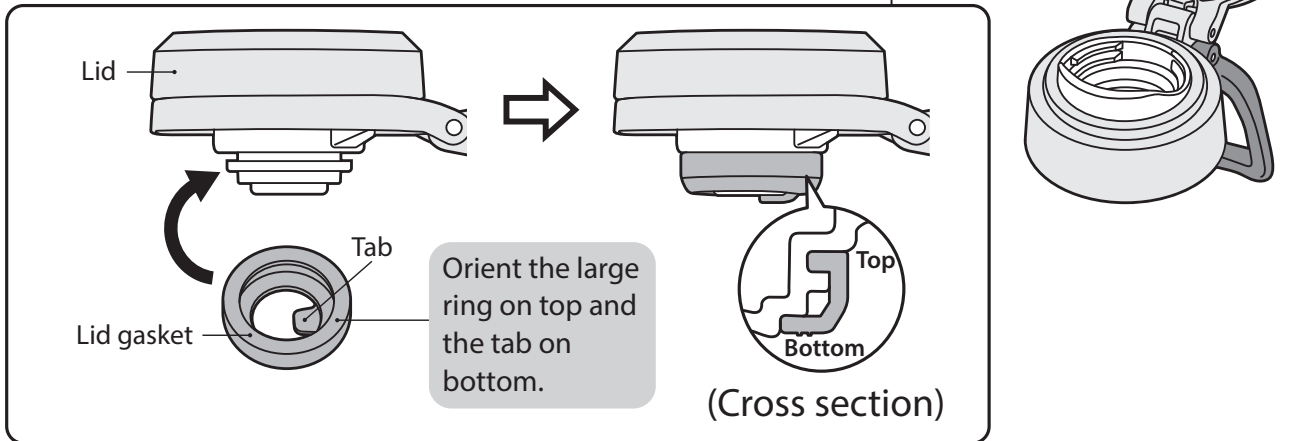

### ② How to attach the stopper gasket

Check which side is the top or bottom, and attach the stopper gasket properly into the groove. After you attach it, press evenly around the gasket with your fingers to ensure that no part is raised.

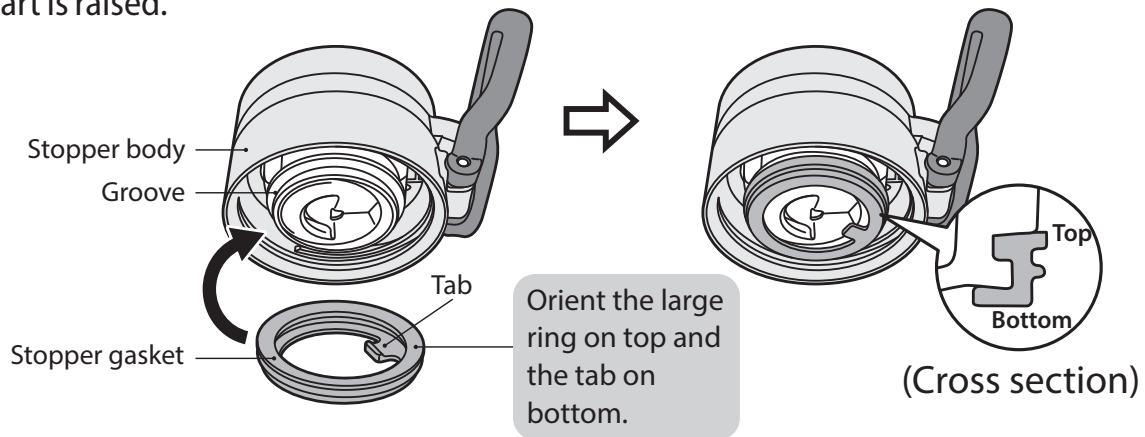

## How to attach the body ring

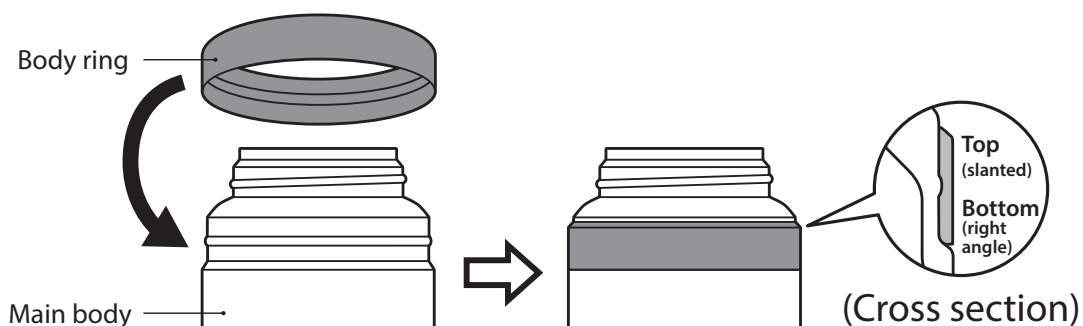

Check which side is the top or bottom, and attach it properly to the main body. After you attach it, press evenly around the body ring with your fingers to ensure that no part is raised.



# Product Care



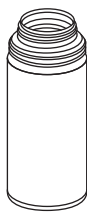

## Normal product care

- Use neutral dish detergent that is diluted in lukewarm water, and after rinsing, drain out all of the water and thoroughly dry the parts.

<p><b>Stopper</b> Loop, lid, stopper body, lid gasket, stopper gasket</p> <p><b>Body ring</b></p> <p><b>Bottom cover</b></p> 	<p>Use a soft sponge.</p> <p>* After product care, be sure that the gaskets are attached in the proper places. </p>
<p><b>Main body</b></p> 	<p>Use a soft sponge or bottle brush.</p> <p>Wipe the outside with a dry cloth immediately after washing.</p> <p>* Otherwise, water droplets may leave marks or cause rust.</p>

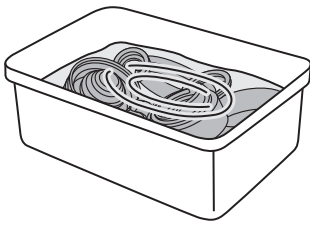

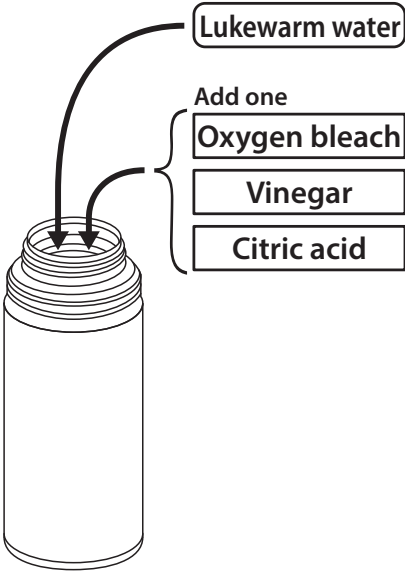







## Thorough product care

- Use kitchen bleach in accordance with its warning label, and after rinsing, drain out all of the water and thoroughly dry the parts.

<p><b>Stopper</b> Loop, lid, stopper body, lid gasket, stopper gasket</p> <p><b>Body ring</b></p> <p><b>Bottom cover</b></p> 	<p><b>For tea stains, etc.</b></p> <p>Mix bleach and water in a bowl or other container, and soak each of the parts. (Approx. 30 min.)</p> <p> <b>Prohibited</b></p> <p>Do not use chlorine bleach for the loop, lid, or stopper body.</p> <p>* Doing so may cause rust or damage the stopper.</p>
<p><b>Main body interior</b></p>  <p>Lukewarm water</p> <p>Add one</p> <ul style="list-style-type: none"> <li>Oxygen bleach</li> <li>Vinegar</li> <li>Citric acid</li> </ul>	<p><b>For tea stains, etc.</b></p> <p>Use oxygen bleach only on the inside. (Approx. 30 min.)</p> <p> <b>Prohibited: Chlorine bleach</b></p> <p>Do not attach the stopper.</p> <p>* Doing so is dangerous, as pressure will rise inside the main body, and the stopper may suddenly fly off.</p> <p><b>Specks of red rust</b></p> <p>This is caused by a buildup of iron and other impurities in the water. Pour a mixture of 90% lukewarm water and 10% vinegar into the main body, and then wait about 30 minutes before rinsing it well.</p> <p><b>Gritty residue</b></p> <p>This is caused by a buildup of calcium and other impurities in the water. Pour a mixture of lukewarm water and 1% to 2% citric acid into the main body, and then leave it for about 3 hours without attaching the stopper before rinsing it well.</p>

# In This Case

If an uncertain situation arises, check the items below.

Issue	Cause	Solution
<b>The stopper is leaking.</b>	The stopper is not securely closed, or it is loose.	When closing the stopper, hold the main body upright, and do not tilt or shake the main body while closing it.  P.6 ③
	The lid is not securely closed, or it is loose.	Close the lid securely.  P.7 ⑤
	Too much drink is inside.	Keep the drink level below the prescribed amount.  P.6 ②
	The gaskets have slipped, or they are not attached securely.	Securely attach the two gaskets in the proper positions.  P.9 ① ②
	The stopper or gaskets are worn.	Purchase replacement parts, which are sold separately.  P.12
<b>The drink does not come out easily.</b>	The spout hole or air vent is blocked by ice or beverage.	Remove the stopper, and lightly shake or tap the product to remove the blockage.
<b>The inside of the main body is discolored.</b>	The interior is stained.	Use oxygen bleach to clean the interior.  P.10
	Specks of rust are attached to the interior.	This is caused by a buildup of iron and other impurities in the water. Use vinegar to clean the interior.  P.10
	Gritty residue is attached to the interior.	This is caused by a buildup of calcium and other impurities in the water. Use citric acid to clean the interior.  P.10
<b>Part of the outside of the main body has discolored to a whitish color.</b>	Dishwasher detergent or limescale has attached to the product.	Run boiling water over the discolored area, and immediately wipe the outside with a dry cloth. If you leave the product wet, the water droplets may leave marks. The main body will become hot, so be careful of burns.
<b>The heat retention (or cold retention) is ineffective.</b>	The drink put inside was not hot (or cold) enough.	Pour a hot (or cold) drink into this product. Preheating (or precooling) the inside of the main body before use is also effective.
	There is not enough drink.	Increase the amount of drink.
<b>The product smells bad.</b>	The inside of the main body or the stopper is dirty.	Clean the product and thoroughly dry it. If this does not remove the smell, use oxygen bleach.  P.10
<b>The gasket is discolored.</b>	The gasket is stained or moldy.	Use bleach to clean the gasket.  P.10 If the dirt or mold cannot be removed, dispose of the gasket and purchase a replacement, which is sold separately.  P.12
<b>Green tea changes color to a reddish brown.</b>		Do not leave your green tea for too long inside. When tea is kept hot, its components are altered, and the color and flavor change, but this is not harmful to humans.
<b>When I shake the product, I hear a faint ringing.</b>		Metal inside the double-layered vacuum structure (vacuum layer), which raises the effectiveness of heat retention (and cold retention), is brushing the sides and making noise. This is not a defect.

# How to Purchase Replacement Parts (Sold Separately)

Confirm the product number and color name, and then make a purchase using the method specified below.

(The product number and color name are indicated on the bottom of the main body.)

① **THERMOS online shop (replacement part sales)**

[https://www.shopthermos.jp/shop/goods/p\\_search.aspx](https://www.shopthermos.jp/shop/goods/p_search.aspx)

Order parts from the URL above.

(Please be aware that the available parts are limited.)

**Web address: <https://www.thermos.jp/>**

To improve the product, some of its specifications may be changed without prior notice. Therefore, please be aware that the illustrations in this guide may differ slightly from the actual product.