

Instruction Manual

Product Number: JEF

Thank you for purchasing the THERMOS Vacuum Insulated Soup Jar. This page gives detailed handling instructions for the product.

For Household Use

Before Use

- Check that all the parts are included.
- Thoroughly clean all parts.

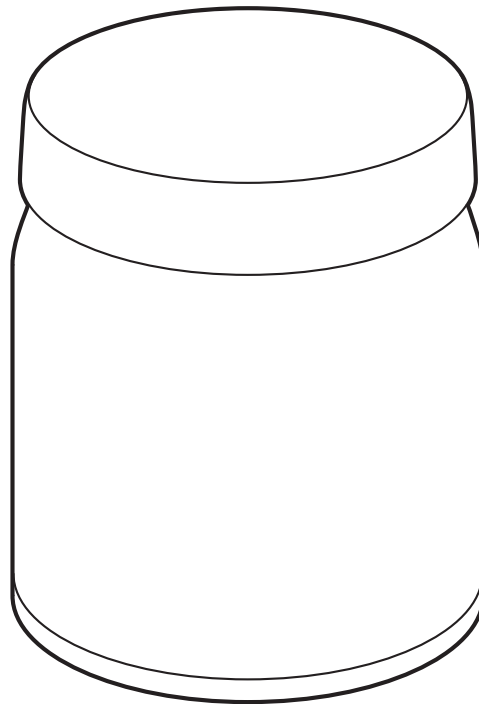

Contents

| | | |
|---------------------------|------|---|
| Before Use | P.1 | Part Names |
| | P.2 | Precautions |
| | P.5 | Notes on Use |
| Usage Instructions | P.6 | How to Use |
| | P.7 | Product Care |
| Troubleshooting | P.10 | In This Case |
| | P.12 | How to Purchase Replacement Parts (Sold Separately) |

Part Names

Before use, check that all the parts are included.

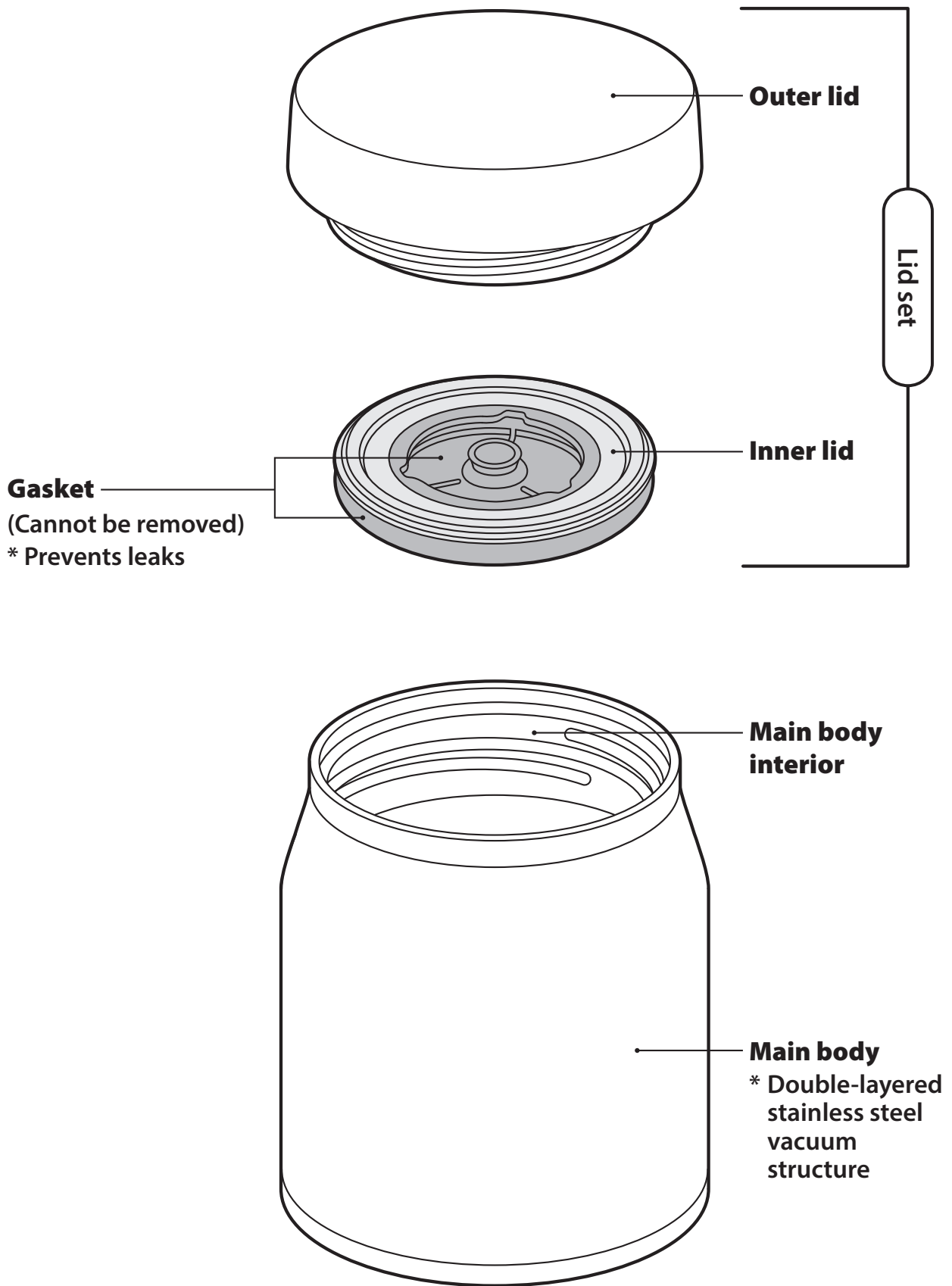

Precautions

Read these precautions carefully before use and be sure to follow them.

Meaning of displayed markings

■ To ensure that this product is properly used, the extent of harm or damage caused by improper usage is categorized as follows.

| | | | |
|--|---|--|---|
|  Warning | This mark indicates content that could result in death or serious injury. |  Caution | This mark indicates content that could result in minor injury or property damage. |
|--|---|--|---|

■ Symbols

| | | | |
|---|---------------------------------------|---|--|
|  Prohibited | This mark indicates actions to avoid. |  Required | This mark indicates actions that must be followed. |
|---|---------------------------------------|---|--|

Warning

 **Keep this product out of reach of young children. Also, make sure it is not used as a toy.**
* This behavior may result in burns or injury.





Caution

 **Use this product only for storing food or drink.**
* Doing so may cause injury.

 **Do not place this product over direct heat or near a stove, gas heater, or other fire source.**
* Doing so may cause burns. Additionally, the product may become deformed, possibly causing leaks that could result in burns or staining your belongings.

 **If drinking directly from the container, do not tilt it quickly.**
* Otherwise, the rush of hot food and liquid may result in burns and other issues.

 **Do not put this product in the microwave.**
* The metal parts will spark, possibly resulting in damage to the microwave.
* Heat may cause the product to become deformed, possibly causing leaks that could result in burns or staining your belongings.

 **Avoid dropping the product, knocking it, or otherwise subjecting it to strong impact.**
* Doing so may cause injury, or the contents may leak, possibly resulting in burns or staining your belongings. Also, the product may lose its heat and cold retention.

 **Do not tilt or shake the main body when closing the lid set.**
* Otherwise, food or drink may overflow. Also, the contents may leak, possibly resulting in burns or staining your belongings.

 **Do not place plastic wrap or similar materials between the inner lid and the container.**
* Otherwise, the contents may leak, possibly resulting in burns or staining your belongings.

Precautions



Required

Keep the food or drink level below the prescribed position illustrated.

* Overfilling may cause the food or drink to overflow when the lid set is closed. Also, the contents may leak during use, possibly resulting in burns or staining your belongings.

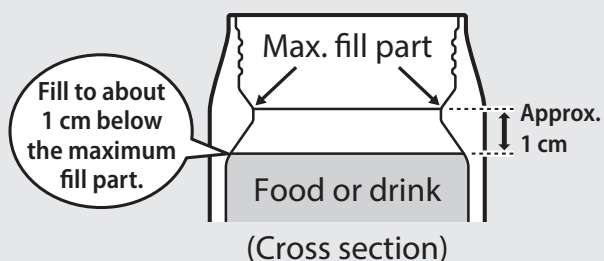

Prohibited

Never put dry ice or carbonated drinks inside the container.

* If the internal pressure rises, the lid set may not open or may fly off, causing the contents to burst out and possibly resulting in injury or staining of your belongings.



Prohibited

Never modify, disassemble, or repair the product.

* Doing so may cause damage or result in an accident.



Required

Be careful of tipping over the product when the main body contains food or drink.

* Doing so may cause burns.

To care for the product, be sure to follow the instructions below.



Prohibited

Do not boil this product.

* Heat may cause the product to become deformed, possibly causing leaks that could result in burns or staining your belongings.



Required

Remove the inner lid from the outer lid before cleaning.

* Otherwise, the water may seep into the gaps and leak, possibly staining your belongings or causing spoilage and odor.



Required

When the product contains hot food or drink, be careful of burns.

* This product is vacuum-insulated, so the exterior does not become hot even when it contains hot food or drink.



Required

Be careful of splashing when draining hot water.

* Doing so may cause burns.



Required

Attach only the dedicated parts to this product.

* Otherwise, the contents may leak, possibly resulting in burns or staining your belongings.



Required

Be sure to attach the inner lid. Also, close the lid set securely. (P.6 ③, P.8 ②)

* Otherwise, the contents may leak, possibly resulting in burns or staining your belongings.

Precautions

Be sure to follow the instructions below.

Before Use



Required

Pour hot (or cold) food or drink into this product. Make sure food or drink is thoroughly heated (brought to a boil) before placing it in the container. After heating, promptly place the food or drink in the container and close the lid set.



Required

Consume the contents as soon as possible (within 6 hours) and finish them in one sitting.



Prohibited

Do not put raw food or other highly perishable items in this product.



Prohibited

Do not leave this product in high-temperature locations, such as inside a vehicle, when it contains cold food or drink.



Prohibited

Do not leave food or drink in the product for extended periods.

* Consuming spoiled food or drink may result in illness.

* If the internal pressure rises due to gases released through spoilage and fermentation, the lid set may not open or may fly off, causing food or drink to burst out and possibly resulting in injury or staining of your belongings.

After Use



Required

After use, immediately clean the product and thoroughly dry it.

* Residue left after washing may grow bacteria and contaminate your food or drink.



Required

If you have gone out or otherwise cannot properly care for the product after use, quickly and thoroughly rinse the interior of the main body with water.

* If the internal pressure rises due to gases released through spoilage or fermentation, the lid set may not open or may fly off, causing food or drink to burst out and possibly resulting in injury or staining of your belongings.



Prohibited

Avoid using this product if you hear sloshing sounds coming from inside of the double-layered vacuum structure (vacuum layer).

* If liquid from the vacuum layer seeps into the main body, consuming it may cause health issues.

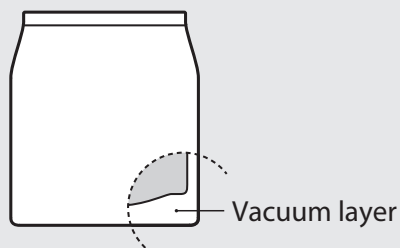

Prohibited

Do not heat the product if the lid set does not open while food or drink is inside.

* If the internal pressure rises, the lid set may fly off, causing food or drink to burst out and possibly resulting in injury or staining of your belongings. If the lid set cannot be opened, refer to "The lid set does not open with food or drink inside" under "In This Case" on P.11 for instructions on how to open it.

Notes on Use

Do not put this product in the freezer.

* Doing so may result in damage or insufficient heat and cold retention.

When carrying the product, place it upright to prevent any potential leaks.

Some parts may deteriorate with prolonged use involving certain ingredients (oils, fats, or citrus peels).

Before going out, turn the product upside down to check for leaks.

* If the product leaks, check the items listed in "In This Case" on P.10.

If the exterior of the main body becomes hot (or cold) when hot (or cold) food or drink is placed inside, this indicates a problem with heat (or cold) retention. Because this may cause spoilage, discontinue using the product.

How to Use

1 Open the lid

Twist the lid set in the direction of the arrow to open it.

Before Use

Thoroughly clean the lid set and the inside of the main body. (👉 P.7)

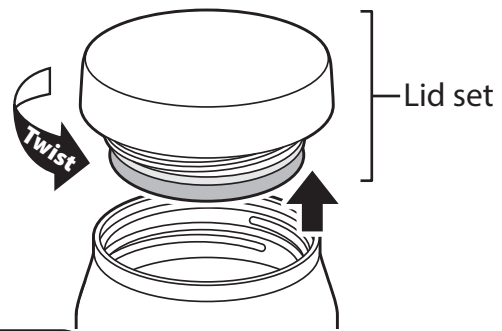

If the inner lid remains on the main body

When opening the lid, the inner lid may detach and remain attached to the main body.

Lift the inner lid upward at an angle to remove it.

* Always attach the inner lid to the outer lid before use. (👉 P.8 ②)

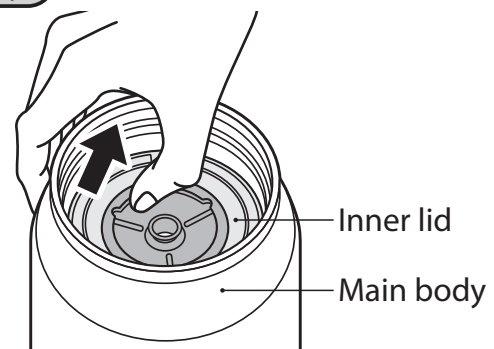

2 Adding food or drink

Pour hot (cold) food or drink into this product. Keep the food or drink level below the prescribed position illustrated. Overfilling may cause the food or drink to overflow when the lid set is closed.

* Make sure the ingredients do not exceed the fill line shown in the illustration.

Point Before inserting the content, insert a small amount of hot water (or cold water) into the main body to preheat (or precool) the inside for about 1 minute. Doing so will increase its heat (or cold) retention ability.



⚠ Caution

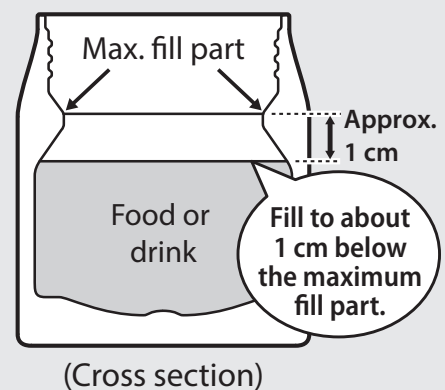

3 Close the lid

Twist the lid set in the direction of the arrow and close it securely.

⚠ Caution

- Confirm that the inner lid is attached. (👉 P.8 ②)
- Opening the lid during heat-retention cooking may cause the temperature to drop and prevent proper cooking.

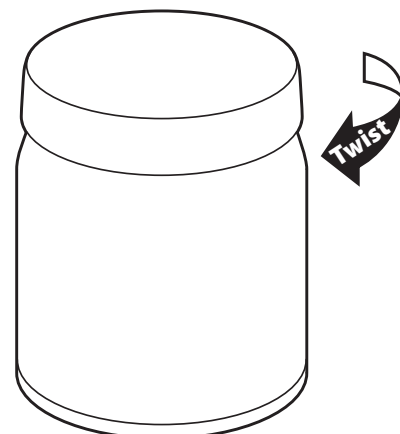

Product Care

To prevent smells, stains, and mold and keep the product clean for a long time, always properly maintain it after use.

- After use, immediately clean the product and thoroughly dry it.
- Remove the inner lid and clean it thoroughly.
- If you will not be using the product for a long time, clean it thoroughly to remove any dirt, thoroughly dry it, and then store it in a place that is not too hot or humid.

| Part name How to wash | | Lid set | | Main body | |
|---------------------------|----------------|-----------|-----------|-----------|---------|
| | | Outer lid | Inner lid | Inside | Outside |
| Running water rinse | | ✓ | ✓ | ✓ | ✓ |
| Soak and wash | | ✓ | ✓ | ✓ | ✗ |
| Bleach | Oxygen-based | ✓ | ✓ | ✓ | ✗ |
| | Chlorine-based | ✓ | ✓ | ✗ | ✗ |
| Dishwasher* Dish dryer | | ✓ | ✓ | ✓ | ✓ |
| Heat resistance | | 100°C | 100°C | — | — |

* Before using a dishwasher, dryer, and detergent, check the instruction manuals to confirm the conditions of washable parts (heat resistance, etc.) and the washing method.

Precautions during Product Care

Before performing product care, read these precautions carefully and be sure to follow them.



Do not boil this product.

* Heat may cause the product to become deformed, possibly causing leaks that could result in burns or staining your belongings.



Do not use chlorine bleach for the main body.

* Otherwise, the product may rust or lose its heat and cold retention.



Do not wash the outside of the main body by soaking.

* Doing so may cause discoloration or peeling of the paint and printing.



If using a dishwasher, do not place the main body on exposed metal parts of the dish rack.

* Otherwise, the paint or printing may peel off.



Do not use paint thinner, benzene, steel scrubbers, polishing powder, or cleansers to clean this product.

* Doing so may cause rust, scratches, or damage.



Required

Remove the inner lid from the outer lid for cleaning and thoroughly dry it before reattaching.

* Water may enter the gaps and cause spoilage or odor.

Product Care

How to remove and attach the gasket and inner lid

■ How to open the lid (👉 P.6 ①)

① How to remove the inner lid

Pull up one side of the inner lid to detach and remove it.

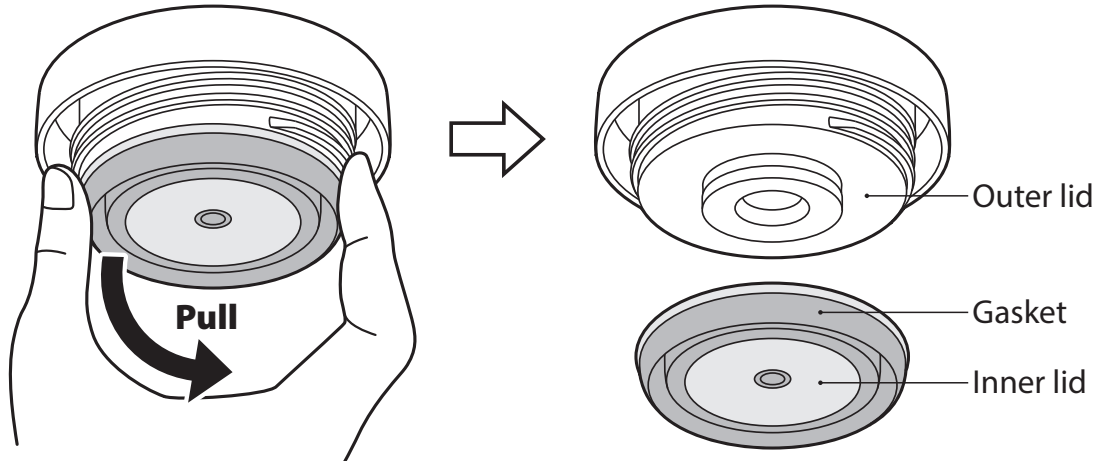

⚠ Caution

The gasket cannot be removed.
Do not pull it forcefully.

* Doing so may damage the gasket and cause leaks.

② Attaching the inner lid

Align the round sections of the outer lid and inner lid, then press the inner lid to snap it into place.

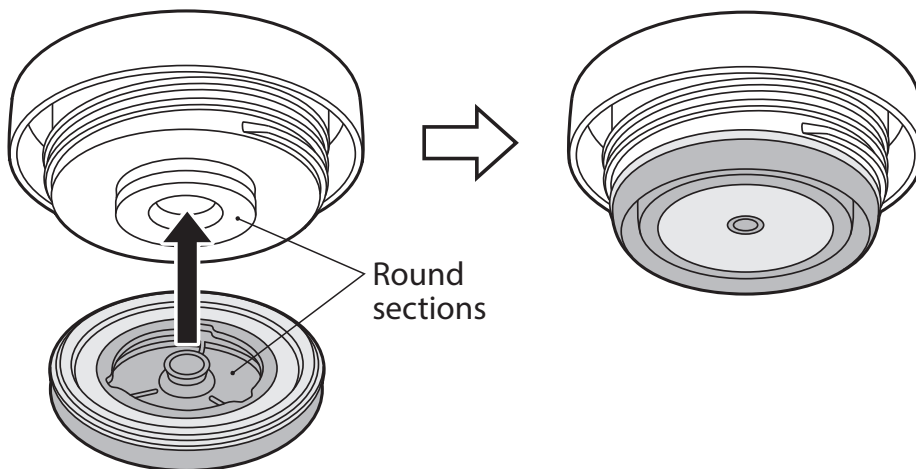

Product Care

Normal product care

- Use neutral dish detergent that is diluted in lukewarm water, and after rinsing, drain out all of the water and thoroughly dry the parts.

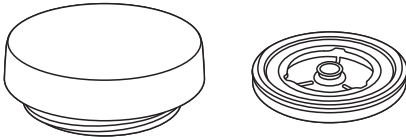
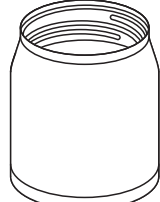
| | |
|--|---|
| <p>Lid set Outer lid, inner lid</p>  | <p>Use a soft sponge. * After product care, be sure that the inner lid is attached in the proper place. (▶▶ P.8 ②)</p> |
| <p>Main body</p>  | <p>Use a soft sponge. Wipe the outside with a dry cloth immediately after washing. * Otherwise, water droplets may leave marks or cause rust.</p> |

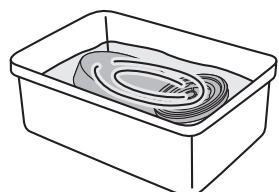
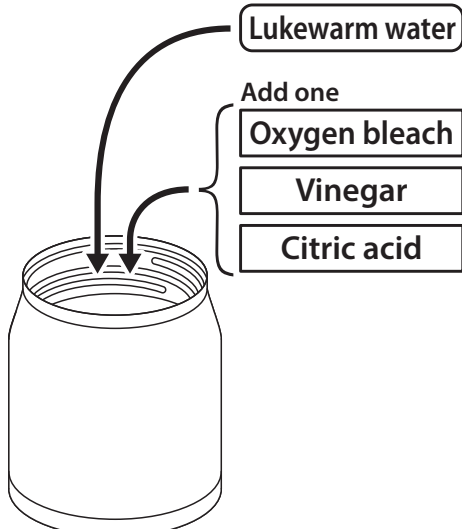

Thorough product care

- Use kitchen bleach in accordance with its warning label, and after rinsing, drain out all of the water and thoroughly dry the parts.

| | |
|--|---|
| <p>Lid set Outer lid, inner lid</p>  | <p>Mix bleach and water in a bowl or other container, and soak each of the parts. (Approx. 30 min.)</p> |
| <p>Main body interior</p>  | <p>Use oxygen bleach only on the inside. (Approx. 30 min.)</p> <p>⊘ Prohibited: Chlorine bleach Do not attach the lid set. * Doing so is dangerous, as pressure will rise inside the main body, and the lid set may suddenly fly off.</p> <p>Specks of red rust This is caused by a buildup of iron and other impurities in the water. Pour a mixture of 90% lukewarm water and 10% vinegar into the main body, and then wait about 30 minutes before rinsing it well.</p> <p>Gritty residue This is caused by a buildup of calcium and other impurities in the water. Pour a mixture of lukewarm water and 1% to 2% citric acid into the main body, and then leave it for about 3 hours without attaching the lid set before rinsing it well.</p> |

In This Case

If an uncertain situation arises, check the items below.

| Issue | Cause | Solution |
|--|--|---|
| Food or drink has leaked. | The lid set is not securely closed. | Close the lid set securely.  P.6  |
| | The inner lid is not attached. | Securely attach the inner lid to the outer lid.  P.8  |
| | There is too much food or drink inside. | Keep the food or drink level below the prescribed amount.  P.6  |
| | The outer lid is damaged or worn. | Purchase a replacement outer lid, which is sold separately.  P.12 |
| | The inner lid is damaged or worn. | Purchase a replacement inner lid, which is sold separately.  P.12 |
| The inside of the main body is discolored. | The interior is stained. | Use oxygen bleach to clean the interior.  P.9 |
| | Specks of rust are attached to the interior. | This is caused by a buildup of iron and other impurities in the water. Use vinegar to clean the interior.  P.9 |
| | Gritty residue is attached to the interior. | This is caused by a buildup of calcium and other impurities in the water. Use citric acid to clean the interior.  P.9 |
| Part of the outside of the main body has discolored to a whitish color. | Dishwasher detergent or limescale has attached to the product. | Run boiling water over the discolored area, and immediately wipe the outside with a dry cloth. If you leave the product wet, the water droplets may leave marks. The main body will become hot, so be careful of burns. |
| Unable to perform heat-retention cooking, or the heat retention (or cold retention) is ineffective. | The food or drink put inside was not hot (or cold) enough. | Pour hot (or cold) food or drink into this product. Preheating (or precooling) the inside of the main body before use is also effective. |
| | There is not enough food or drink. | Increase the amount of food or drink. |
| | The lid is open during thermal cooking. | Opening the lid during heat-retention cooking may lower the temperature and prevent proper cooking. Keep the lid closed during heat-retention cooking. |
| | Ingredients are too large. | Large ingredients may prevent heat from transferring sufficiently. Cut ingredients into smaller pieces or partially cook them before heat-retention cooking. |
| The product smells bad. | The interior is stained. | Clean the product and thoroughly dry it. If this does not remove the smell, follow the product care instructions and use oxygen bleach.  P.9 |

In This Case

If an uncertain situation arises, check the items below.

| Issue | Cause | Solution |
|---|---|---|
| The inner lid is discolored. | The straw or gasket is stained or moldy. | Use bleach to clean the gasket. (👉 P.9) If the dirt or mold cannot be removed, dispose of the gasket and purchase a replacement, which is sold separately. (👉 P.12) |
| Food or drink has spoiled. | The contents were stored for too long. | Consume the contents as soon as possible (within 6 hours) and finish them in one sitting. |
| | Raw foods were placed inside. | Do not put raw food or other highly perishable items in this product. |
| The lid set will not open with food or drink inside. | The lid set may be overtightened, or the contents may have spoiled. | Place the product upright and use a dedicated tool, such as an opener, to open it. |
| When I shake the product, I hear a faint ringing. | | Metal inside the double-layered vacuum structure (vacuum layer), which raises the effectiveness of heat retention (and cold retention), is brushing the sides and making noise. This is not a defect. |

How to Purchase Replacement Parts (Sold Separately)

Confirm the product number and color name, and then make a purchase using the method specified below.

(The product number and color name are indicated on the bottom of the main body.)

① THERMOS online shop (replacement part sales)

https://www.shopthermos.jp/shop/goods/p_search.aspx

Order parts from the URL above.

(Please be aware that the available parts are limited.)

Web address: <https://www.thermos.jp/>

To improve the product, some of its specifications may be changed without prior notice. Therefore, please be aware that the illustrations in this guide may differ slightly from the actual product.