

Instruction Manual

Product Number: J0S

Thank you for purchasing the THERMOS Vacuum Insulated Portable Mug.
This page gives detailed handling instructions for the product.

For Household Use

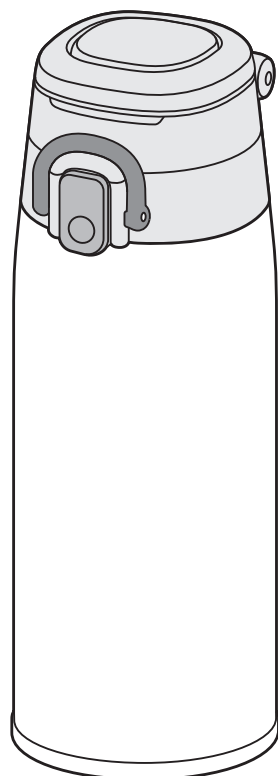

Before Use

- Check that all the parts are included.
- Thoroughly clean all parts.

If you overfill the liquid, the contents may leak.

Fill drink to here!

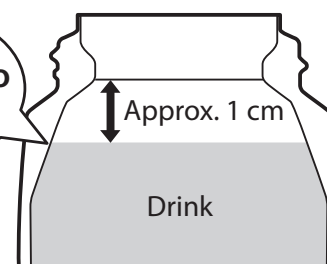

(Main body cross section)

Contents

Before Use

- P.1 Part Names
- P.2 Precautions
- P.5 Notes on Use

Usage Instructions

- P.6 How to Use
- P.8 Product Care

Troubleshooting

- P.12 In This Case
- P.13 How to Purchase Replacement Parts (Sold Separately)

Part Names

Before use, check that all the parts are included.

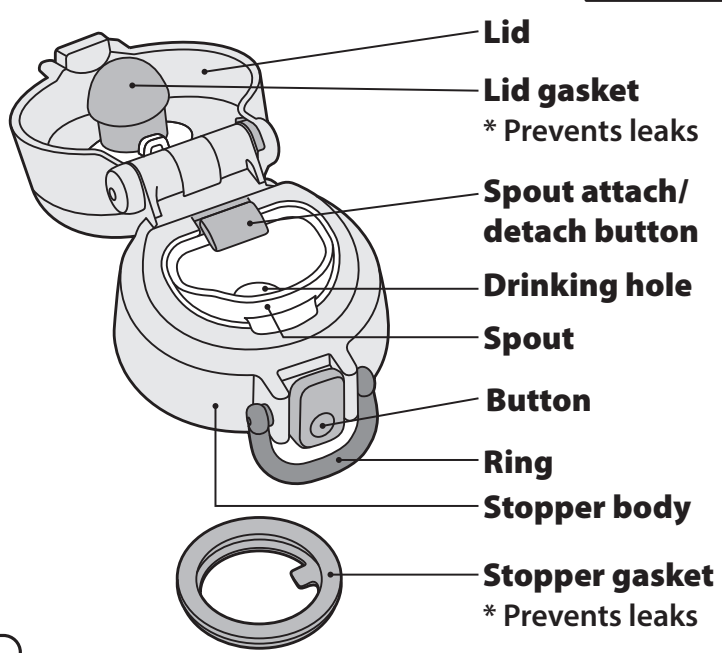
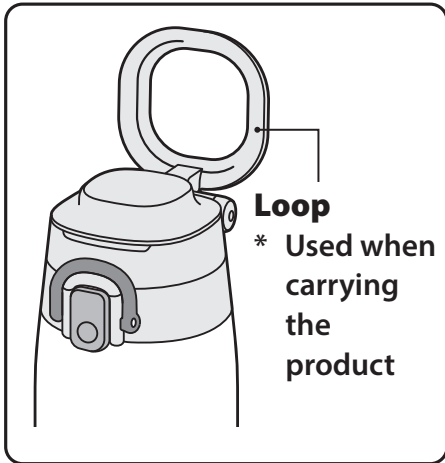

Stopper

Caution

Keep the drink level below the position illustrated. If overfilled, the contents may leak.

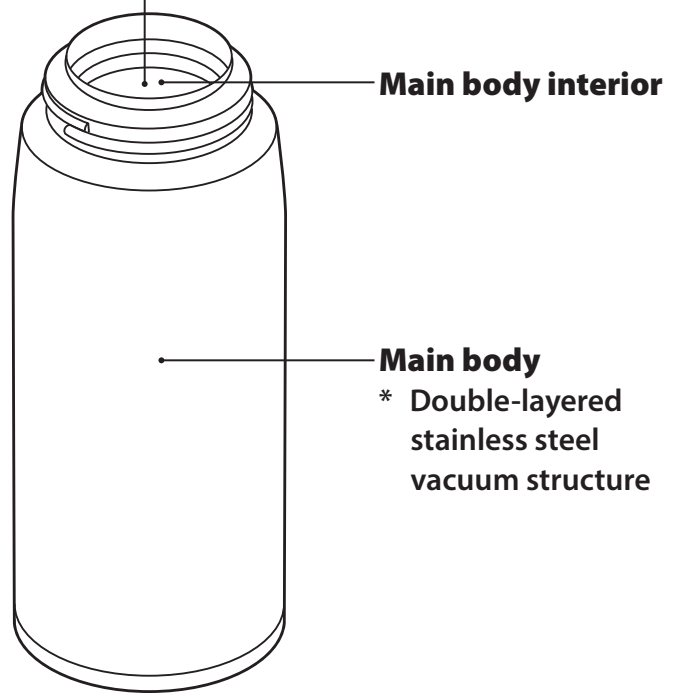
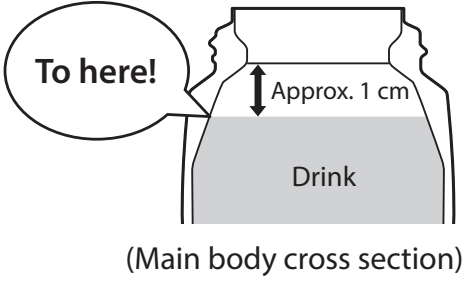

Remove the spout to clean it.

(👉 P.9 ①)

Spout attach/detach button

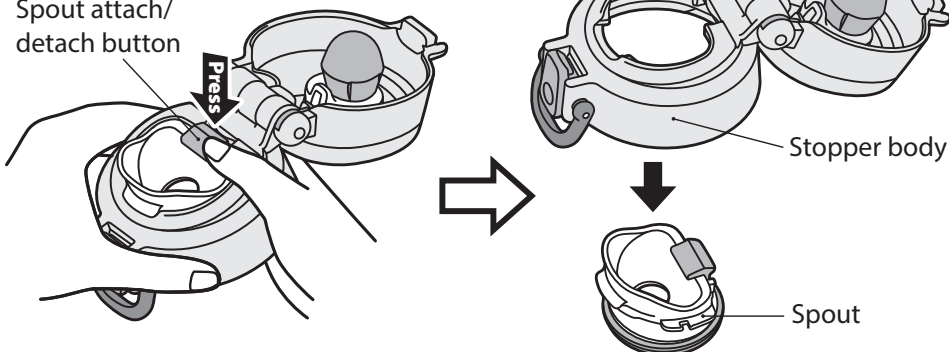

Properly attach the stopper's two dedicated gaskets before use.

* Otherwise, the contents may leak.

Precautions

Read these precautions carefully before use and be sure to follow them.

Meaning of displayed markings

■ To ensure that this product is properly used, the extent of harm or damage caused by improper usage is categorized as follows.

| | | | |
|--|---|--|---|
|  Warning | This mark indicates content that could result in death or serious injury. |  Caution | This mark indicates content that could result in minor injury or property damage. |
|--|---|--|---|

■ Symbols

| | | | |
|---|---------------------------------------|---|--|
|  Prohibited | This mark indicates actions to avoid. |  Required | This mark indicates actions that must be followed. |
|---|---------------------------------------|---|--|

Warning

 **Keep this product out of reach of young children.**
Prohibited **Also, make sure it is not used as a toy.**

* Small parts are a choking hazard and are at risk of being swallowed. Also, this behavior may result in burns or injury.



Caution

 **Do not use this product for purposes other than drink storage.**
Prohibited
* Doing so may cause injury.

 **Do not leave this product near a stove, gas heater, or other fire source.**
Prohibited

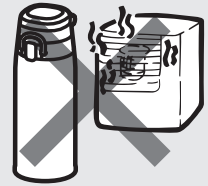

* Doing so may cause burns.

Additionally, the product may become deformed, possibly causing leaks that could result in burns or staining your belongings.

When storing hot drinks, be sure to follow the instructions below.

 **Do not open the lid of the stopper when tilting it or holding it near your face.**
Prohibited

* Your drink may be expelled suddenly and splatter due to internal pressure, possibly resulting in burns and other issues.

 **When drinking a hot beverage, drink slowly and do not tilt the main body quickly.**
Required

* Otherwise, the rush of hot liquid may result in burns and other issues.

 **Properly attach the stopper's two dedicated gaskets.**
Required



( P.9 ④, P.10 ⑤)

* Otherwise, the contents may leak, possibly resulting in burns or staining your belongings.

 **Close the stopper securely.**
Required

( P.6 ③)

* Otherwise, the contents may leak, possibly resulting in burns or staining your belongings.

 **Ensure that the spout is securely attached to the stopper body before use. ( P.10 ⑥)**
Required

* Otherwise, the contents may leak, possibly resulting in burns or staining your belongings.

 **Do not leave your beverage for too long inside.**
Required

* Otherwise, the drink may spoil or go bad.

Precautions

Required  **Keep the drink level below the prescribed position illustrated.**

- * Overfilling may cause the drink to overflow when closing the stopper. Also, the contents may leak during use, possibly resulting in burns or staining your belongings.

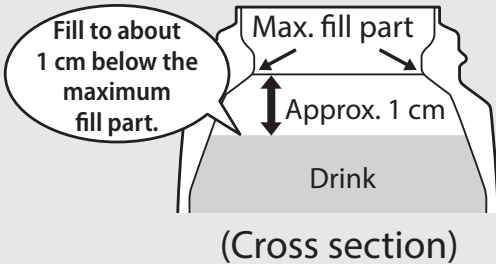

Prohibited  **Do not tilt or shake the main body when closing the stopper.**

( P.6 ③)

- * Otherwise, the drink may overflow. Also, the contents may leak, possibly resulting in burns or staining your belongings.

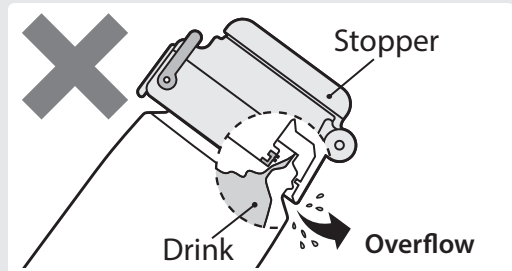

Never put the following inside the container.

Prohibited  **Dry ice and carbonated drinks**

- * If the internal pressure rises, the stopper may not open or may fly off, causing the contents to burst out and possibly resulting in injury or staining your belongings.

Prohibited  **Tea leaves and pulp**

- * If the spout hole or crevices become clogged, the contents may leak, possibly resulting in burns or staining your belongings.

Prohibited  **Avoid dropping the product, knocking it, or otherwise subjecting it to strong impact.**

- * Doing so may cause injury, or the contents may leak, possibly resulting in burns or staining your belongings. It can also result in insufficient heat and cold retention or a damaged stopper.

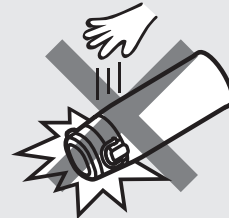

To care for the product, be sure to follow the instructions below.

Required  **After use, immediately clean the product and thoroughly dry it.**

- * Residue left after washing may grow bacteria and contaminate your drinks.

Prohibited  **Do not boil this product.**

- * Heat may cause the product to become deformed, possibly causing leaks that could result in burns or staining your belongings.

Prohibited  **Do not use a dishwasher or dish dryer to wash the product. (Except for gaskets)**

- * Heat may cause the product to become deformed, possibly causing leaks that could result in burns or staining your belongings.

Prohibited  **Do not leave a drink in this product for a long time.**

- * Otherwise, the drink may spoil or go bad. Also, if the internal pressure rises due to gases released through spoilage, the stopper may not open or may fly off, causing the contents to burst out and possibly resulting in injury or staining your belongings.

Required  **Avoid cramming large pieces of ice inside. Break them into smaller pieces.**

- * The maximum fill part on the inside of the main body may become deformed possibly causing leaks that could result in burns or staining your belongings.

Precautions



Do not carry or swing around the product while holding the ring.

- * The lid may open and the liquid may spill out, possibly resulting in burns or staining your belongings.
- * Your fingers may get pinched or the product may fall, possibly causing injury. Doing so may also damage the ring.



Do not swing around the product while holding the loop and do not pull the loop forcefully.

- * Doing so may cause the product to strike people around you, possibly causing injury or damaging the product. Also, the contents may leak, possibly resulting in burns or staining your belongings.



Do not put this product in the microwave.

- * The metal parts will spark, possibly resulting in damage to the microwave.
- * Heat may cause the product to become deformed, possibly causing leaks that could result in burns or staining your belongings.

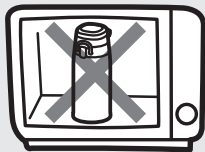

Never modify, disassemble, or repair the product.

- * Doing so may cause damage or result in an accident.



Do not attach or remove the stopper while the lid of the stopper is open.

- * Deformation or damage may cause leaks, possibly resulting in burns or staining your belongings.



Avoid using this product if you hear sloshing sounds coming from inside of the double-layered vacuum structure (vacuum layer).

- * If liquid from the vacuum layer seeps into the main body, consuming it may cause health issues.

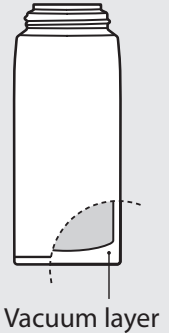

Attach only the dedicated parts to this product.

- * Otherwise, the contents may leak, possibly resulting in burns or staining your belongings.



Be careful of tipping over the product when the main body contains a drink.

- * Otherwise, the drink may spill, possibly resulting in burns or staining your belongings.



If the heat or cold retention is reduced, stop using the product.

- * Storing a hot drink will heat up the main body, possibly resulting in burns.

Notes on Use

Refrain from inserting soups and other high-salt content items, as well as warm sports drinks, into the container.

* The main body uses stainless steel for its interior lining. However, exposure to salt may potentially cause rusting and diminish its ability to keep beverages hot or cold for an extended period.

After use, immediately clean the product and thoroughly dry it. If you have gone out or otherwise cannot properly care for the product after use, quickly and thoroughly rinse the interior of the main body with water.

* Otherwise, the product may rust or lose its heat and cold retention.

When placing the product in a bag, place it upright to prevent any potential leaks.

Before going out, turn the product upside down to check for leaks.

* If the product leaks, check the items listed in "In This Case" on P.12.

Do not put this product in the freezer.

* Doing so may result in damage or insufficient heat and cold retention.

When carrying the product, be sure to follow the instructions below.

- **Confirm that the stopper and lid are securely closed and the ring is locked.**
- **Do not turn the stopper in the direction that loosens it or subject it to strong impact.**

* Doing so may loosen the stopper and cause the main body to drop.

Do not open or close the stopper while holding the loop.

* Doing so may damage the loop.

When carrying the product, be sure that the ring is locked.

Do not peel off the protective sheet at the bottom of the main body.

* The product may lose its heat and cold retention.



Protecting sheet

How to Use

Thoroughly clean all parts before use.

1 Remove the stopper

Twist the stopper in the direction of the arrow to remove it.

Before use

- Thoroughly clean the stopper and the inside of the main body. (☞ P.8)
- Confirm that the lid gasket and stopper gasket are properly attached. (☞ P.9 ④, P.10 ⑤)

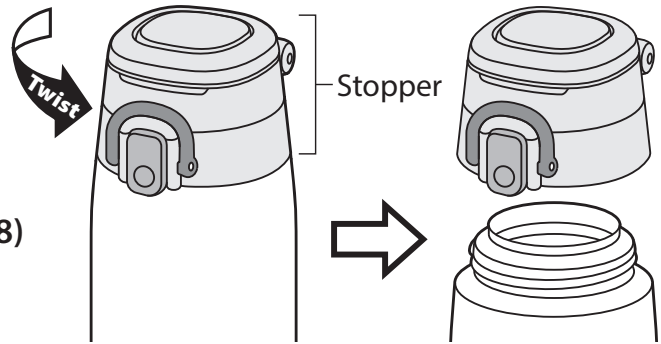

2 Pour in your drink

Keep the drink level below the prescribed position illustrated. Overfilling may cause the drink to overflow when closing the stopper.

Point



Before inserting the content, insert a small amount of hot water (or cold water) into the main body to preheat (or precool) the inside for about 1 minute. Doing so will increase its heat (or cold) retention ability.

Caution

Fill to about 1 cm below the maximum fill part.

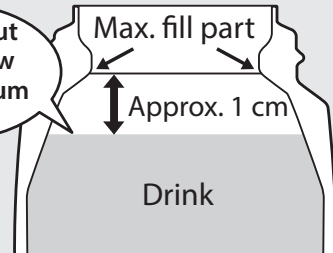

(Cross section)

3 Close the stopper

With the lid closed, twist the stopper in the direction of the arrow and close it securely.

- * Confirm that the spout and stopper gasket are securely attached.
- * Confirm that the ring is locked.

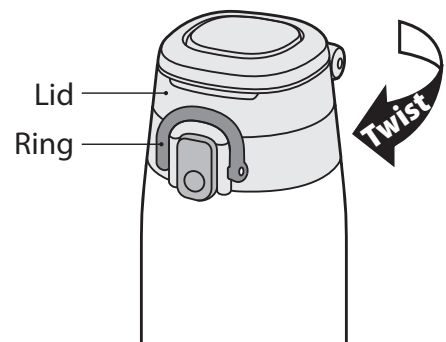

Caution

Do not tilt or shake the main body when closing the stopper.

- * If the drink overflows, it may spill, possibly resulting in burns or staining your belongings.

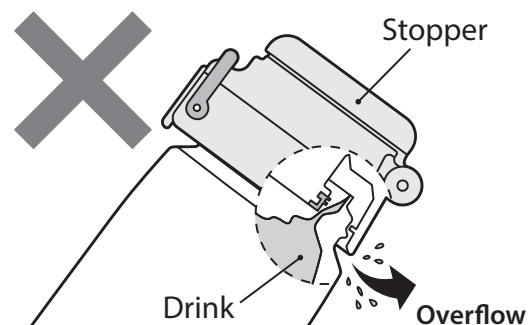

How to Use

4 Drink your beverage

① With the main body upright, move the ring in the direction of the arrow to release it.

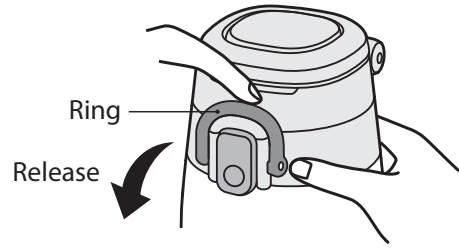

② Press **the bottom of the button** to open the lid. (Move the lid to the position where it becomes fixed.)

⚠ Caution

Do not open the lid while tilting the product.
* Your hot drink may be expelled suddenly and splatter, possibly resulting in burns and other issues.

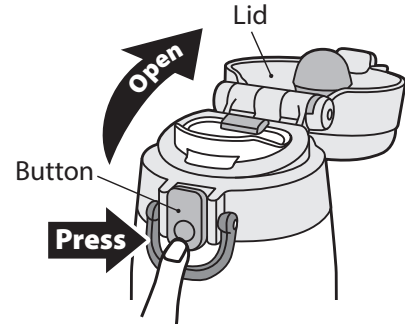

③ Bring the spout to your mouth, and drink while tilting slowly. (When the product contains a hot drink, be careful of burns.)

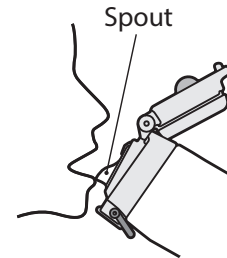

5 When finished drinking

① With the main body upright, press the lid to close it securely.

② Move the ring in the direction of the arrow to lock it.

⚠ Caution

Do not leave the lid open.
* If the product tips over, the drink may spill, possibly resulting in burns or staining your belongings.
When placing the product in a bag, place it upright to prevent any potential leaks.

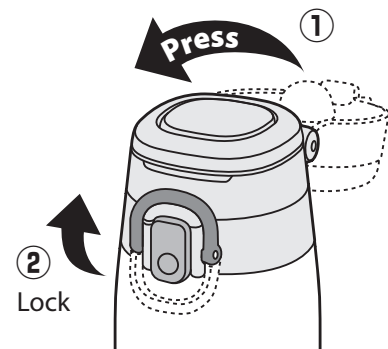

When carrying the product

- Confirm that the stopper and lid are securely closed and the ring is locked.
- Do not turn the stopper in the direction that loosens it or subject it to strong impact.
- Close the loop when not using it.

In this case

- The lid does not open.
 - The stopper cannot be removed.
- * Try the items listed under "In This Case" on P.12. Do not attempt to forcibly remove the stopper. Doing so may damage the product. (👉 P.12)

Product Care

To prevent smells, stains, and mold and keep the product clean for a long time, always properly maintain it after use.

- After use, immediately clean the product and thoroughly dry it.
- Remove the spout and gaskets, and clean them thoroughly.
- If you will not be using the product for a long time, clean it thoroughly to remove any dirt, thoroughly dry it, and then store it in a place that is not too hot or humid.

| Part name | | Stopper | | | Main body | |
|---------------------------|----------------|--------------------------|-------|------------------------------|-----------|---------|
| | | Loop Lid Stopper body | Spout | Lid gasket Stopper gasket | Inside | Outside |
| How to wash | | | | | | |
| Running water rinse | | ✓ | ✓ | ✓ | ✓ | ✓ |
| Soak and wash | | ✓ | ✓ | ✓ | ✓ | ✗ |
| Bleach | Oxygen-based | ✓ | ✓ | ✓ | ✓ | ✗ |
| | Chlorine-based | ✗ | ✓ | ✓ | ✗ | ✗ |
| Dishwasher* Dish dryer | | ✗ | ✗ | ✓ | ✗ | ✗ |
| Heat resistance | | — | — | 140°C | — | — |

* Before using a dishwasher, dryer, and detergent, check the instruction manuals to confirm the conditions of washable parts (heat resistance, etc.) and the washing method.

Precautions during Product Care

Before performing product care, read these precautions carefully and be sure to follow them.

 **Do not boil this product.**
 * Heat may cause the product to become deformed, possibly causing leaks that could result in burns or staining your belongings.

 **Do not use a dishwasher or dish dryer to wash the product. (Except for gaskets)**
 * Heat may cause the product to become deformed, possibly causing leaks that could result in burns or staining your belongings. Additionally, the paint, printing, or stickers may peel off.

 **Do not leave the main body in water.**
 * Water may enter the gaps and the product may rust or lose its heat and cold retention.

 **Do not use paint thinner, benzine, steel scrubbers, polishing powder, or cleansers to clean this product.**
 * Doing so may cause rust, scratches, or damage.

 **Do not use chlorine bleach (except on the spout and gaskets).**
 * The product may rust or lose its heat and cold retention. Doing so may also damage the stopper.

 **Do not use bleach to clean the outside of the main body.**
 * The paint, printing, or stickers may peel off.

Product Care

Attaching and removing the spout and gaskets

■ How to remove the stopper (👉 P.6 ①)

1 How to remove the spout

Press the spout attach/detach button inward and press the spout out in a downward direction.

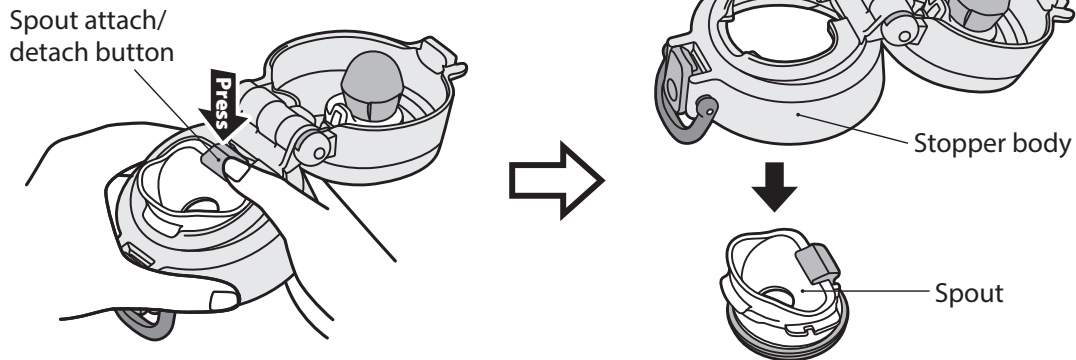

2 How to remove the lid gasket

Pinch the lid gasket and pull it off.

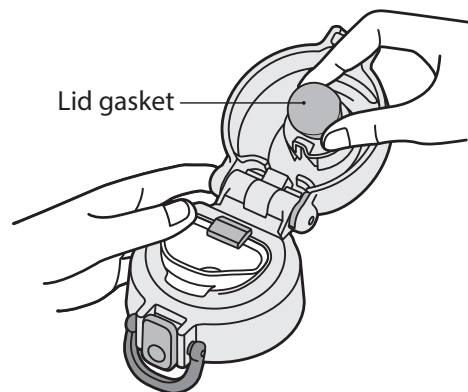

3 How to remove the stopper gasket

Pinch the tab of the stopper gasket and pull it off.

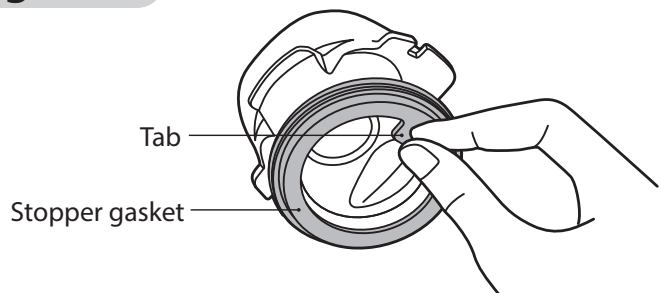

4 How to attach the lid gasket

Fit the lid gasket onto the protrusion of the lid and press it all the way to the base of the protrusion so there is no gap.

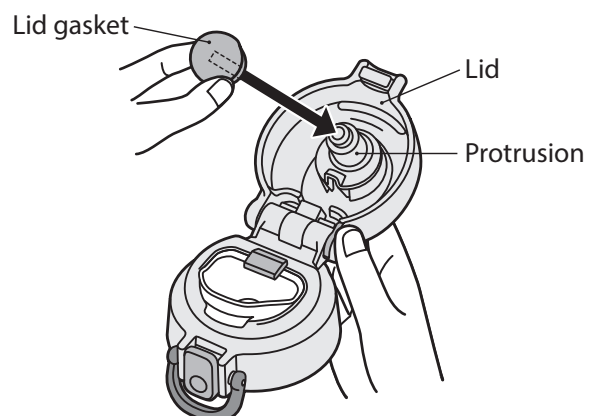

Product Care

5 How to attach the stopper gasket

Check which side is the top or bottom, and attach the stopper gasket properly to the spout. After you attach it, press evenly around the stopper gasket with your fingers to ensure that no part is raised.

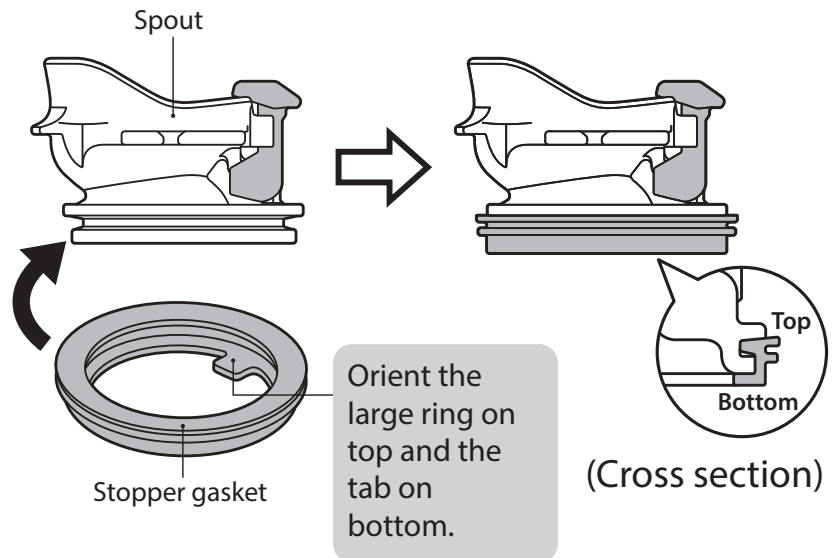

6 How to attach the spout

- ① With the lid open, insert the spout from the area below the stopper body and then place the ridge of the spout on the indent of the stopper body.
- ② Press the spout from the bottom until you hear a click to attach it securely.

Request

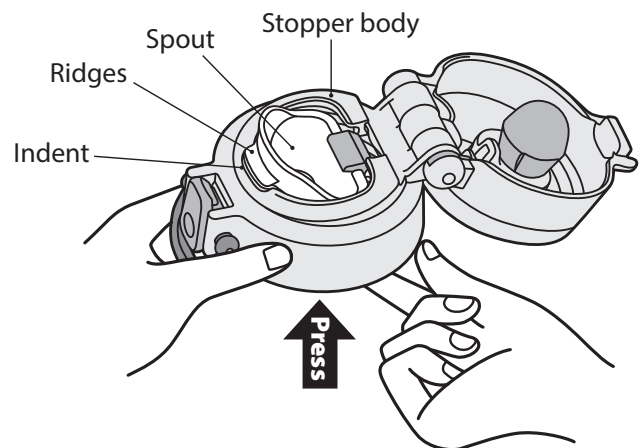

After attaching the spout and gaskets, open and close the lid, and confirm that the lid securely closes.



Product Care

Normal product care

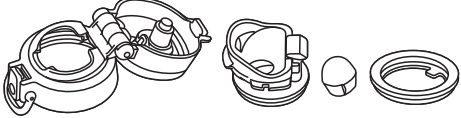
- Use neutral dish detergent that is diluted in lukewarm water, and after rinsing, drain out all of the water and thoroughly dry the parts.

| | |
|--|---|
| <p>Stopper Loop, lid, stopper body, spout, lid gasket, stopper gasket</p>  | <p>Use a soft sponge.</p> <ul style="list-style-type: none"> * After product care, be sure that the spout and gaskets are attached in the proper places. (P.9 4, P.10 5 6) |
| <p>Main body</p>  | <p>Use a soft sponge or bottle brush. Wipe the outside with a dry cloth immediately after washing.</p> <ul style="list-style-type: none"> * Otherwise, water droplets may leave marks or cause rust. |

Thorough product care

- Use kitchen bleach in accordance with its warning label, and after rinsing, drain out all of the water and thoroughly dry the parts.

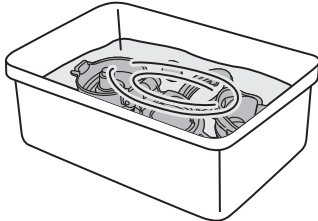
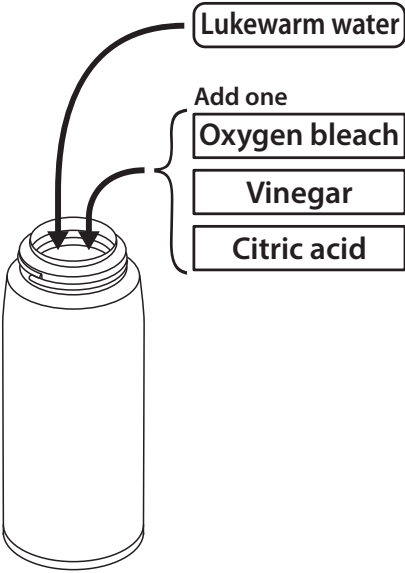
| | |
|--|---|
| <p>Stopper Loop, lid, stopper body, spout, lid gasket, stopper gasket</p>  | <p>For tea stains, etc. Mix bleach and water in a bowl or other container, and soak each of the parts. (Approx. 30 min.)</p> <p>Prohibited</p> <p>Do not use chlorine bleach for the loop, lid, or stopper body.</p> <ul style="list-style-type: none"> * Doing so may cause rust or damage the stopper. |
| <p>Main body interior</p>  | <p>For tea stains, etc. Use oxygen bleach only on the inside. (Approx. 30 min.)</p> <p>Prohibited: Chlorine bleach</p> <p>Do not attach the stopper during this process.</p> <ul style="list-style-type: none"> * Doing so is dangerous, as pressure will rise inside the main body, and the stopper may suddenly fly off. <p>If you see specks of red rust This is caused by a buildup of iron and other impurities in the water. Pour a mixture of 90% lukewarm water and 10% vinegar into the main body, and then wait about 30 minutes before rinsing it well.</p> <p>Gritty residue This is caused by a buildup of calcium and other impurities in the water. Pour a mixture of lukewarm water and 1% to 2% citric acid into the main body, and then leave it for about 3 hours without attaching the stopper before rinsing it well.</p> |

In This Case

If an uncertain situation arises, check the items below.

| Issue | Cause | Solution |
|--|--|--|
| The stopper is leaking. | The stopper is not securely closed, or it is loose. | When closing the stopper, hold the main body upright, and do not tilt or shake the main body while closing it. (👉 P.6 ③) |
| | The lid is not securely closed. | Close the lid securely, and securely lock the ring. (👉 P.7 ⑤) |
| | Too much drink is inside. | Keep the drink level below the prescribed amount. (👉 P.6 ②) |
| | The gaskets have slipped. | Securely attach the two gaskets in the proper positions. (👉 P.9 ④, P.10 ⑤) |
| | The spout is not attached. | Be sure to attach the spout. (👉 P.10 ⑥) |
| | The stopper or gaskets are worn. | Purchase replacement parts, which are sold separately. (👉 P.13) |
| The drink does not come out easily. | The drink hole is blocked by ice or beverage. | Remove the stopper and spout, and lightly shake or tap the product to remove the blockage. |
| The inside of the main body is discolored. | The interior is stained. | Use oxygen bleach to clean the interior. (👉 P.11) |
| | Specks of rust are attached to the interior. | This is caused by a buildup of iron and other impurities in the water. Use vinegar to clean the interior. (👉 P.11) |
| | Gritty residue is attached to the interior. | This is caused by a buildup of calcium and other impurities in the water. Use citric acid to clean the interior. (👉 P.11) |
| The heat retention (or cold retention) is ineffective. | The drink put inside was not hot (or cold) enough. | Pour a hot (or cold) drink into this product. Preheating (or pre-cooling) the inside of the main body before use is also effective. |
| | There is not enough drink. | Increase the amount of drink. |
| The product smells bad. | The inside of the main body or the stopper is dirty. | Clean the product and thoroughly dry it. If this does not remove the smell, use oxygen bleach. (👉 P.11) |
| The gasket is discolored. | The gasket is stained or moldy. | Use bleach to clean the gasket. (👉 P.11) If the dirt or mold cannot be removed, dispose of the gasket and purchase a replacement, which is sold separately. (👉 P.13) |
| Green tea changes color to a reddish brown. | | Do not leave your green tea for too long inside. When tea is kept hot, its components are altered, and the color and flavor change, but this is not harmful to humans. |
| When I shake the product, I hear a faint ringing. | | Metal inside the double-layered vacuum structure (vacuum layer), which raises the effectiveness of heat retention (and cold retention), is brushing the sides and making noise. This is not a defect. |
| The lid does not open. The stopper cannot be removed. | | This situation occurs when a hot drink is left inside for a long time and the temperature of the drink cools, causing the pressure inside the main body to lower (decompress). Open the lid by hand, and then close the lid again before removing the stopper. |

How to Purchase Replacement Parts (Sold Separately)

Confirm the product number and color name, and then make a purchase using the method specified below.

(The product number and color name are indicated on the bottom of the main body.)

① THERMOS online shop (replacement part sales)

https://www.shopthermos.jp/shop/goods/p_search.aspx

Order parts from the URL above.

(Please be aware that the available parts are limited.)

Web address

<https://www.thermos.jp/>

To improve the product, some of its specifications may be changed without prior notice. Therefore, please be aware that the illustrations in this guide may differ slightly from the actual product.